

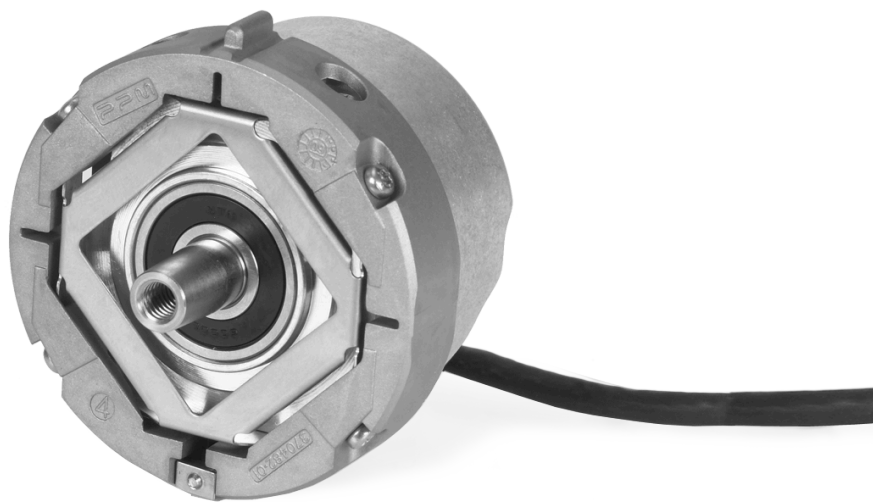

HEIDENHAIN



Product Information

ECN 425 **EQN 437**

Absolute Rotary
Encoders with Tapered
Shaft and Expanding
Ring Coupling for Safety-
Related Applications

**Functional
Safety**

09/2019

ECN 425, EQN 437

Rotary encoders for absolute position values with safe singletum information

- 65 mm installation diameter
- 07B expanding ring coupling
- 65B tapered shaft
- IP64 rating

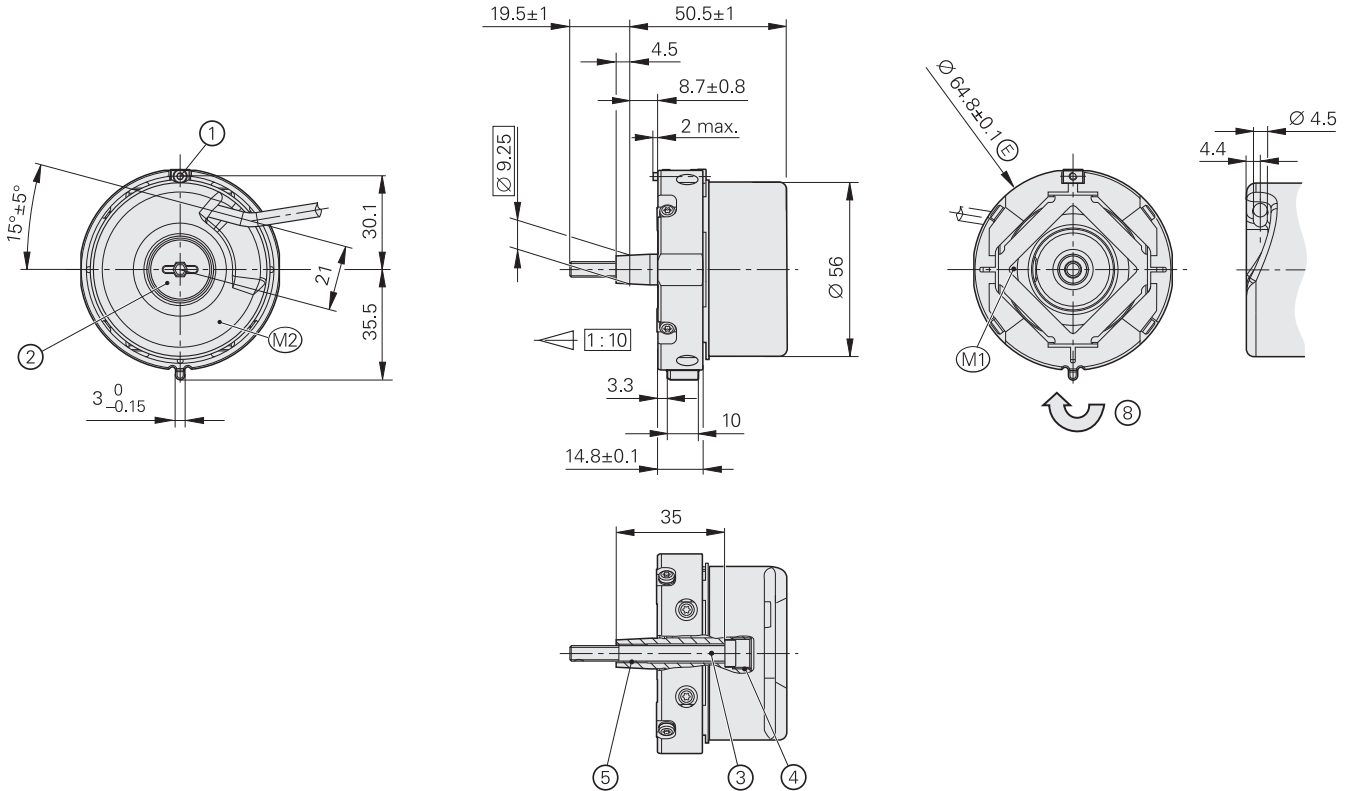
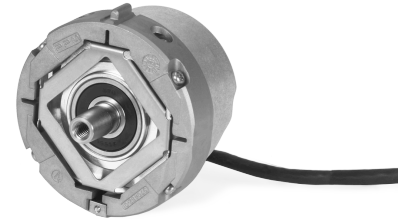

Required mating dimensions

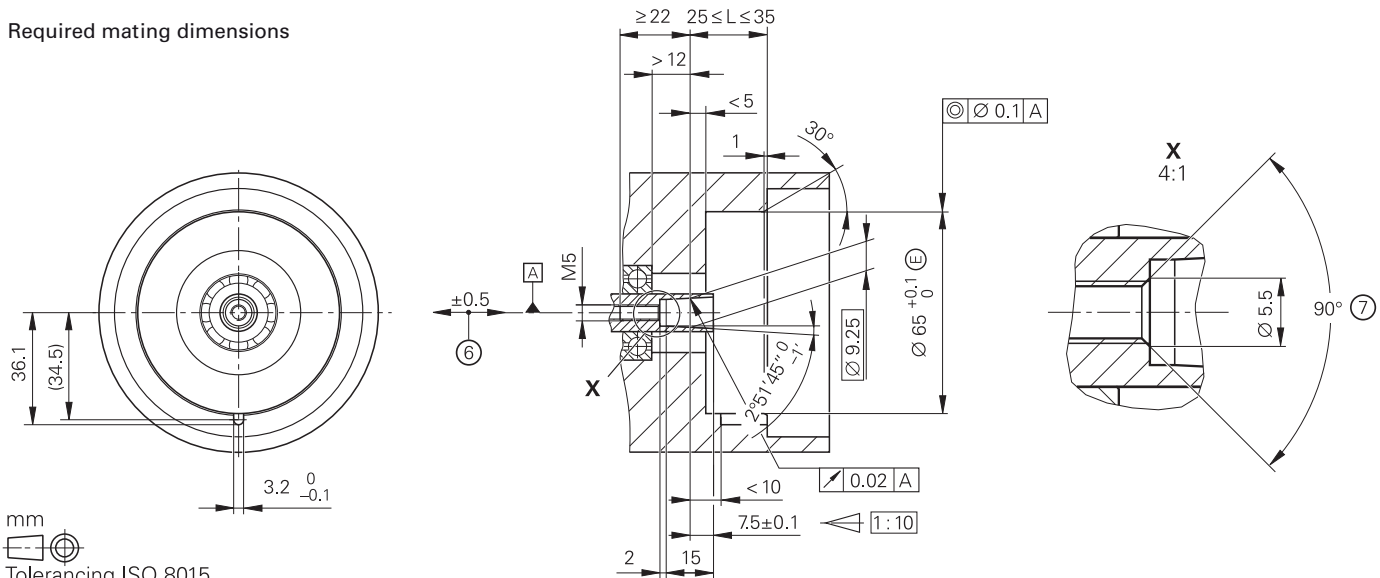

mm

 Tolerancing ISO 8015
 ISO 2768 - m H
 < 6 mm: ±0.2 mm

- ☐ = Bearing of mating shaft
- M1= Measuring point for operating temperature
- M2= Measuring point for vibration, see D 741714
- 1 = Clamping screw for coupling ring, width A/F 2, tightening torque: 1.25 Nm -0.2 Nm
- 2 = Screw plug, widths A/F 3 and 4, tightening torque: 5 Nm +0.5 Nm
- 3 = Screw: DIN 6912 - M5x50-08.8 - MKL, width A/F 4, tightening torque: 5 Nm +0.5 Nm
- 4 = M10 back-off thread
- 5 = M6 back-off thread
- 6 = Compensation of mounting tolerances and thermal expansion; no dynamic motion permitted
- 7 = Chamfer at start of thread is obligatory for material bonding anti-rotation lock
- 8 = Direction of shaft rotation for ascending position values

Specifications	ECN 425 – Singleturn	EQN 437 – Multiturn
Functional safety for applications up to	As single-encoder system for monitoring functions <ul style="list-style-type: none"> • SIL 1 as per EN 61508 (further basis for testing: EN 61800-5-2) • Category 2, PL c as per EN ISO 13849-1:2015 As single-encoder system for closed-loop functions <ul style="list-style-type: none"> • SIL 2 as per EN 61508 (further basis for testing: EN 61800-5-2) • Category 3, PL d as per EN ISO 13849-1:2015 Safe in the singleturn range	
PFH	$\leq 10 \cdot 10^{-9}$ (probability of dangerous failure per hour)	
Safe position ¹⁾	<i>Encoder: $\pm 1.76^\circ$ (safety-related measuring step: SM = 0.7°)</i> <i>Mechanical coupling: $\pm 2^\circ$ (fault exclusion for the loosening of shaft and stator coupling, designed for accelerations $\leq 300 \text{ m/s}^2$)</i>	
Interface	EnDat 2.2	
Ordering designation	EnDat22	
Position values per revolution	33 554 432 (25 bits)	
Revolutions	-	4096 (12 bits)
Calculation time t_{cal} Clock frequency	$\leq 7 \mu\text{s}$ $\leq 8 \text{ MHz}$	
System accuracy	$\pm 20''$	
Electrical connection	Cable (1 m) with 8-pin M12 coupling (male)	
Cable length	$\leq 100 \text{ m}$ (see the EnDat description in the <i>Interfaces of HEIDENHAIN Encoders</i> brochure)	
Supply voltage	DC 3.6 V to 14 V	
Power consumption ²⁾ (max.)	<i>At 3.6 V: $\leq 600 \text{ mW}$; at 14 V: $\leq 700 \text{ mW}$</i>	<i>At 3.6 V: $\leq 700 \text{ mW}$; at 14 V: $\leq 800 \text{ mW}$</i>
Current consumption (typical)	<i>At 5 V: 85 mA (without load)</i>	<i>At 5 V: 105 mA (without load)</i>
Shaft	65B tapered shaft $\varnothing 9.25 \text{ mm}$; taper 1:10	
Shaft speed	$\leq 15\,000 \text{ rpm}$	$\leq 12\,000 \text{ rpm}$
Starting torque at 20 °C (typical)	0.01 Nm	
Moment of inertia of rotor	$2.6 \cdot 10^{-6} \text{ kgm}^2$	
Angular acceleration of rotor	$\leq 1 \cdot 10^5 \text{ rad/s}^2$	
Natural frequency of stator coupling	$\geq 1800 \text{ Hz}$	
Axial motion of measured shaft	$\leq \pm 0.5 \text{ mm}$	
Vibration 55 Hz to 2000 Hz Shock 6 ms	$\leq 300 \text{ m/s}^2$ (EN 60068-2-6); 10 Hz to 55 Hz constant over 4.9 mm peak to peak $\leq 2000 \text{ m/s}^2$ (EN 60068-2-27)	
Min. operating temperature	<i>Stationary cable: -40°C; moving cable: -10°C</i>	
Max. operating temperature	100 °C	
Trigger threshold of error message for temperature exceedance	125 °C (measuring accuracy of the internal temperature sensor: $\pm 4 \text{ K}$)	
Relative humidity	$\leq 93 \%$ (40 °C/21 d as per EN 60068-2-78); without condensation	
Protection class EN 60529	IP64 (read about insulation under <i>General mechanical information</i> in the <i>Interfaces of HEIDENHAIN Encoders</i> brochure; contamination from the ingress of liquids must be prevented)	
Mass	$\approx 0.25 \text{ kg}$	
ID number	ID 678920-02	ID 678922-02

- 1) Further tolerances may arise in subsequent electronics after pos. value comparison (contact manufacturer of subsequent electronics)
 2) See *General electrical information* in the *Interfaces of HEIDENHAIN Encoders* brochure

Mounting

The tapered shaft of the rotary encoder is slid onto the measured shaft and fastened with a central screw. It is particularly important to ensure that the positive-locking element of the stator coupling securely engages the corresponding slot in the measured shaft. Use a screw with material bonding anti-rotation lock (see *Mounting accessories*). The stator coupling is clamped by an axially tightened screw in a location hole.

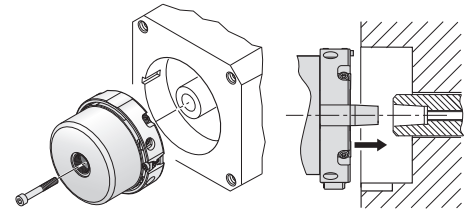

Requirements on the motor side for safe mechanical coupling:

	Mating shaft	Mating stator
Material	Steel	Aluminum
Tensile strength R_m	$\geq 600 \text{ N/mm}^2$	$\geq 220 \text{ N/mm}^2$
Interface pressure P_G	$\geq 500 \text{ N/mm}^2$	$\geq 200 \text{ N/mm}^2$
Surface roughness R_z	$\leq 16 \mu\text{m}$	
Coefficient of thermal expansion α_{therm}	$10 \cdot 10^{-6} \text{ K}^{-1}$ to $17 \cdot 10^{-6} \text{ K}^{-1}$	$\leq 25 \cdot 10^{-6} \text{ K}^{-1}$

For the design of the mechanical fault exclusion for the shaft connection, the following maximum torque M_{max} must be considered:

$$M_{\text{max}} = 1.0 \text{ Nm}$$

The customer's mechanical design must ensure that the maximum torque M_{max} occurring in the application can be transmitted.

Mounting accessories

Screws

Screws (central screw, mounting screws) are not included in delivery and can be ordered separately.



ECN 425, EQN 437	Screws ¹⁾		Quantity
Central screw for shaft fastening	DIN 6912 – M5×50-08.8 – MKL	ID 202264-54	10 or 100

1) With coating for material bonding anti-rotation lock

For further mounting information and mounting aids, please refer to the relevant mounting instructions and the *Encoders for Servo Drives* brochure. The mounting can be tested with the PWM 21 and the ATS software.

Electrical connection

Cables with M12 connecting elements

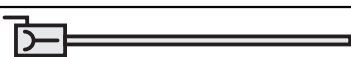
PUR connecting cables and adapter cables Ø 6 mm; 2 × (2 × 0.09 mm ²) + 2 × (2 × 0.16 mm ²); A _P = 2 × 0.16 mm ²		
Connecting cable with 8-pin M12 connector (female) and 8-pin M12 coupling (male)		ID 1036372-xx
Adapter cable with 8-pin M12 connector (female) and 15-pin D-sub connector (female)		ID 1036521-xx
Adapter cable with 8-pin M12 connector (female) and 15-pin D-sub connector (male)		ID 1036526-xx
Connecting cable with 8-pin M12 connector (female) and unstripped cable end		ID 1129581-xx ¹⁾





A_P: Cross section of power supply lines

1) Connecting element must be suitable for the maximum clock frequency used

Conformity with the EMC Directive must be ensured for the complete system!

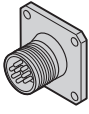
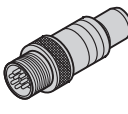
Note for safety-related applications: Document the bit error rate in accordance with Specification 533095!

Pin layout

8-pin M12 coupling								
								
	Power supply				Absolute position values			
	8	2	5	1	3	4	7	6
	U_P	Sensor U_P	0 V	Sensor 0 V	DATA	DATA	CLOCK	CLOCK
	Brown/Green	Blue	White/Green	White	Gray	Pink	Violet	Yellow

Cable shield connected to housing; **U_P** = Power supply

Sensor: The sense line is connected in the encoder with the corresponding power supply.

Vacant pins and wires must not be used!

Note for safety-related applications: Only completely assembled HEIDENHAIN cables are qualified. Do not modify cables or exchange their connectors without first consulting with HEIDENHAIN Traunreut.

SpeedTEC is a registered trademark of TE Connectivity Industrial GmbH

HEIDENHAIN

DR. JOHANNES HEIDENHAIN GmbH

Dr.-Johannes-Heidenhain-Straße 5

83301 Traunreut, Germany

☎ +49 8669 31-0

FAX +49 8669 32-5061

E-mail: info@heidenhain.de

www.heidenhain.de

896586 · 03 · A · 01 · 09/2019 · PDF

This Product Information document supersedes all previous editions, which thereby become invalid. The basis for ordering from HEIDENHAIN is always the Product Information document edition valid when the order is made.

 **Further information:** Comply with the requirements described in the following documents to ensure correct operation of the encoder:

- Brochure: *Encoders for Servo Drives* 208922-xx
- Brochure: *Interfaces of HEIDENHAIN Encoders* 1078628-xx
- Brochure: *Cables and Connectors* 1206103-xx
- Mounting instructions: *ECN 425, EQN 437* 727583-xx
- Technical Information document: *Safety-Related Position Measuring Systems* 596632-xx
- For implementation in a safe control or inverter: *Specification* 533095-xx